5G onBoard Plus - Advanced 5G/WiFi Connectivity System

Code: PF AN NWIFI18

5G onBoard Plus Black - Advanced 5G/WiFi Connectivity System

Code: PF AN NWIFI19

Thank you for purchasing a Scout product. This guide refers to all the 5G/WiFi systems listed above, before installing the router and the antenna(s) please read carefully all instructions. Customer comments are welcome.

Safety information

Before starting operating the device, please review recommendations and precautions to minimize the possibility of accidents. Safety precautions presented are supplementary and subject to the local safety regulations. When various operations are executed on the device, the user must fully follow the safety instructions and recommendations provided with the device.

RF exposure

This device meets the official requirements for exposure to radio waves. This device is designed and manufactured not to exceed the emission limits for exposure to radio frequency (RF) energy set by authorized agencies. The device must be used with a minimum separation of 20 cm from a person's body to ensure compliance with RF exposure guidelines. Failure to observe these instructions could result in your RF exposure exceeding the applicable limits.

The external antenna must be installed to provide a distance of at least 20 cm from any people and must not be co-located or operated in conjunction with any other antenna or transmitter.

Router operating conditions

- Operating temperature: -40° to +75° Celsius
- Humidity should be in the range of 10% to 90% (non-condensing). Only use the device in dry environments.
- Out of direct sunlight
- Away from heat source, corrosive substances, salts, and flammable gases

Faulty and damaged products

- Do not attempt to disassemble the device or its accessories.
- Only qualified personnel must service or repair the device or its accessories.
- If your device or its accessories have been submerged in water punctured or subjected to a severe fall, do not use until they have been checked at an authorized service center.

Electrical safety

- Only use approved accessories.
- Do not connect with incompatible products or accessories.
- It is recommended to ground devices with grounding terminals before connecting them to power. Failure to ground appropriately might result in a shock hazard. The cross-sectional area of the protective grounding conductor should be at least 1mm².

Product handling

- You alone are responsible for how you use your device and any consequences related to its use.
- Use of your device is subject to safety measures designed to protect users and their environment.
- Always treat your device and its accessories with care and keep it in a clean and dust-free place.
- Do not expose your device or its accessories to open flames, lit tobacco products, liquid, moisture, or high humidity.
- Do not drop, throw or try to bend your device or its accessories.
- Do not use harsh chemicals, cleaning solvents, or aerosols to clean the device or its accessories.
- Do not paint your device or its accessories.
- Do not attempt to disassemble your device (exemptions for devices that require disassembly for SIM insertion) or its accessories: it does not contain any user-serviceable parts. For safety reasons, the equipment should be opened only by qualified personnel.
- Make sure to use ESD personal protective equipment while the equipment is serviced.
- Do not use your device in an enclosed environment where heat dissipation is poor.
- Prolonged use in such space may cause excessive heat and raise ambient temperature, which will lead to the automatic shutdown of your device or the disconnection of the mobile network connection for your safety. To use your device again after such a shutdown, cool it in a well-ventilated place before turning it on.
- Please check all national laws and local regulations for the disposal of electronic products.
- Do not operate the device where ventilation is restricted.
- Do not use or install this product near water to avoid fire or shock hazards.
- Avoid exposing the equipment to rain or damp areas.
- Arrange power and Ethernet cables so that they are not likely to be stepped on or have items placed on them.
- Ensure that the voltage and the rated current of the power source match the device's requirements. Do not connect the device to an inappropriate power source.
- During a thunderstorm, no operations should be carried out on the device and cables.
- The unit must be powered off where blasting is in progress and explosive atmospheres are present or near medical life support equipment.
- Do not leave your device and its accessories within reach of small children or allow them to play with it. They could hurt themselves or others and could accidentally damage the device. Your device contains small parts with sharp edges that may cause an injury choking hazard.
- Like any wireless device, this device operates using radio signals, which cannot guarantee connection in all conditions. Therefore, you must never rely solely on any wireless device for emergency communications or otherwise use the device in situations where the interruption of data connectivity could lead to death, personal injury, property damage, data, or other loss.
- The device may become warm during regular use.

Antenna installation

The dome encloses 4 high-gain 5G ready antennas, built in UV-resistant material, IP68. It must be installed in a position close to the router to avoid signal losses along the connection cables as much as possible.

Scout supplies **cable extension** of 5m length (ref. code PF AC NCBLE0022) with SMA male/SMA female connectors. **The maximum suggested distance between the dome and the router is 6m.**

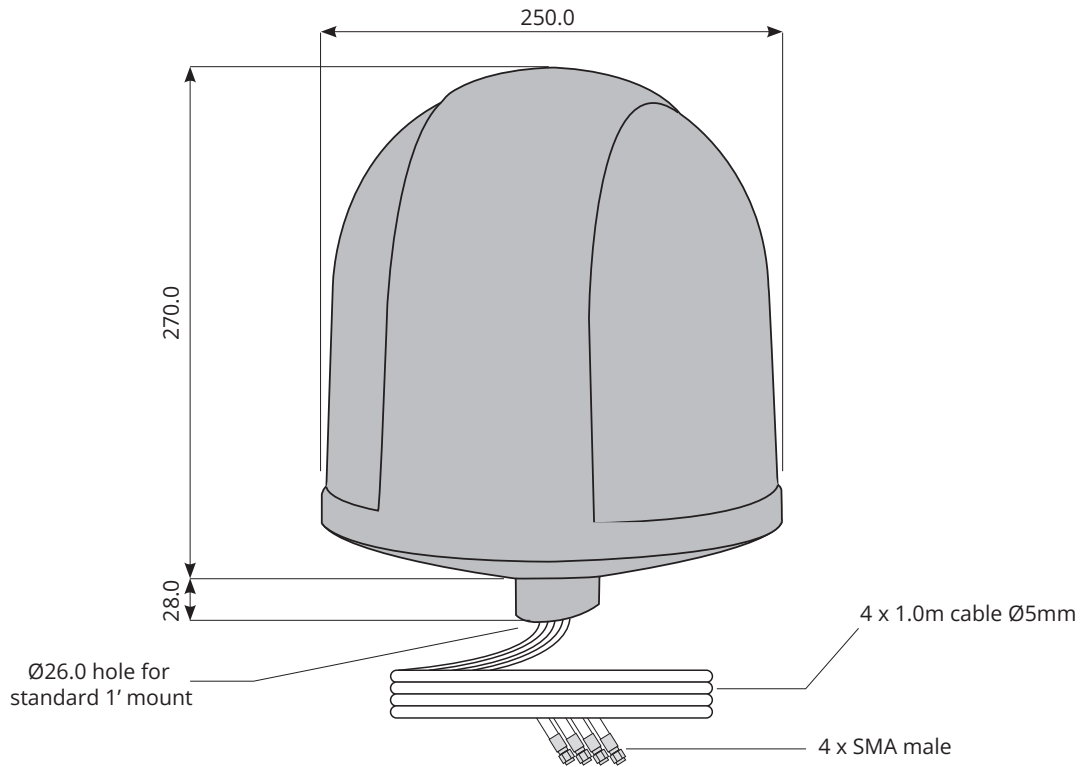

Mounting accessories

Scout supplies several deck mounts and rails mounts for installing the dome.



One way nylon mount
4 cm (2") high

PA-1

cod. PF AC NBASE015



One way stainless steel
mount 4 cm (2") high

PA-42

cod. PF AC NBASE016



One way nylon mount
10 cm (4") high

PA-7

cod. PF AC NBASE020



One way stainless steel
mount 10 cm (4") high

PA-40

cod. PF AC NBASE013



Stainless steel rail
mount

PA-83

cod. PF AC NBASE017

Installation type

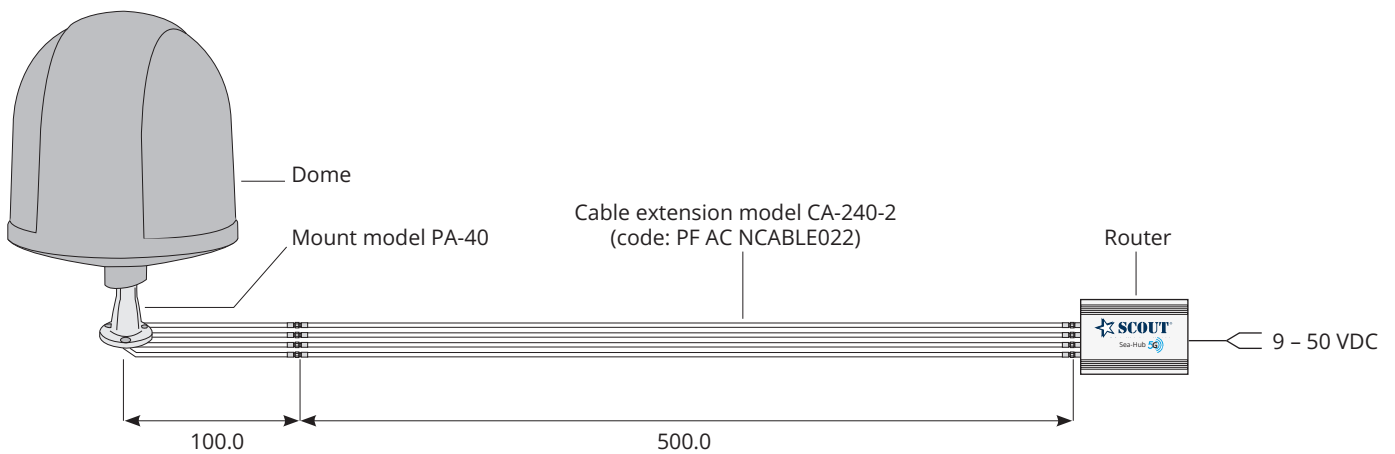

Router specifications

Mobile:	5G Sub-6Ghz SA/NSA 2.1/3.3Gbps DL (4x4 MIMO), 900/600 Mbps UL (2x2); 4G (LTE) – LTE Cat 20 2.0Gbps DL, 200Mbps UL; 3G – 42 Mbps DL, 5.76Mbps UL
CPU:	Quad-core ARM Cortex A7, 717 MHz
RAM	256 MB
Powering options	4-pin power socket, 9-50 VDC
SIM	2 x SIM slot (Mini SIM – 2FF), 1.8 V/3 V
Antenna connectors	4 x SMA for Mobile, 2 x RP-SMA for WiFi, 1 x SMA for GNSS
Ethernet	5 x 10/100/1000 Ethernet ports: 1 x WAN (configurable as LAN), 4 x LAN
WiFi	802.11b/g/n/ac Wave 2 (WiFi 5) with data transmission rates of up to 867 Mbps (Dual Band, MU-MIMO), 802.11r fast transition, Access Point (AP), Station (STA)
Status LEDs	3 x connection status LEDs, 3 x connection strength LEDs, 10 x Ethernet port status LEDs, 4 x WAN status LEDs, 1x Power LED, 2 x 2.4G and 5G WiFi LEDs
Operating temperature:	-40 °C to 75 °C
Housing	Aluminum housing, DIN rail (can be mounted on two sides), flat surface placement
Dimensions (W x H x D)	132 x 44.2 x 95.1 mm
Weight:	533 g

Router front view

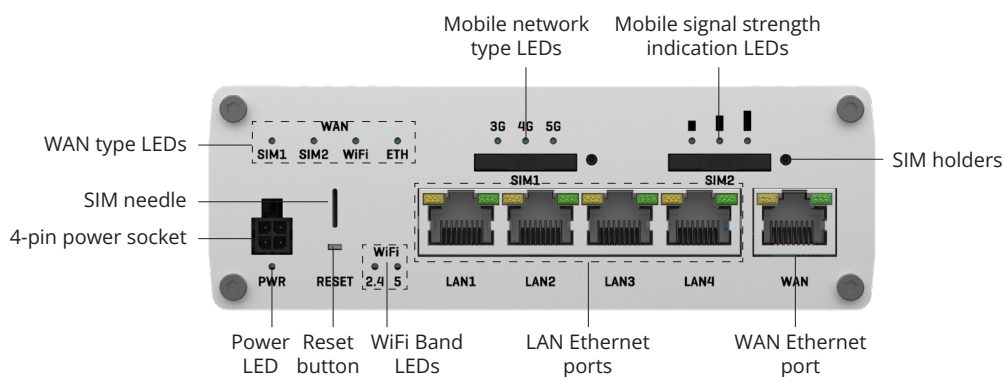

Router back view

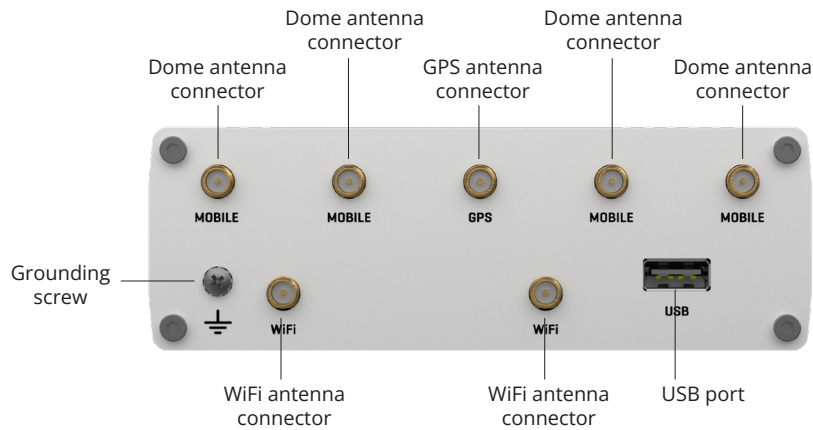

Connectors

Power socket pinout

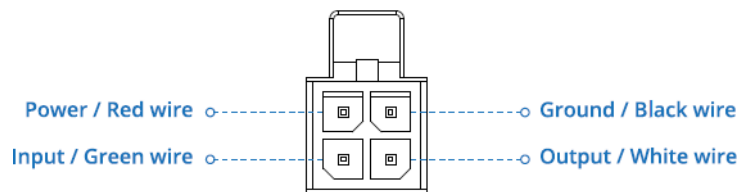

Router installation

Locate the SIM adapter kit

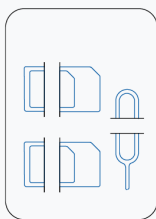

Push the SIM holder button with the SIM needle

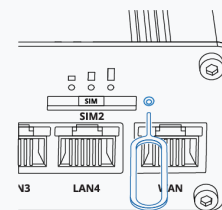

Pull out the SIM holder

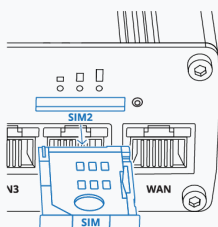

Insert your SIM card into the SIM holder

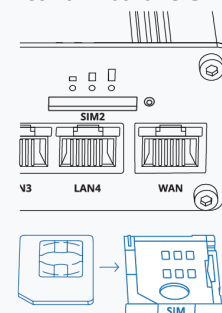

Slide the SIM holder back into the router

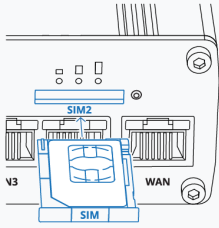

Attach the external antenna cables to connectors labeled "Mobile"

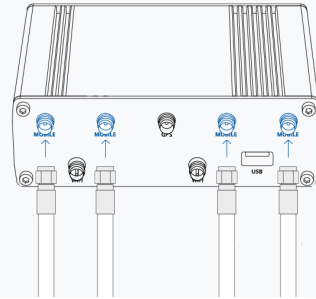

Attach both WiFi antennas to connectors labeled "WiFi"

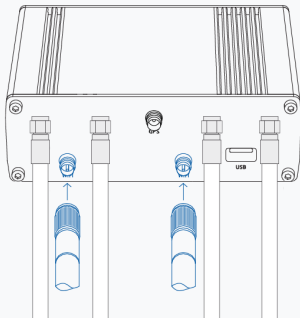

Power up the router by plugging in the 4-pin connector to the socket in the router

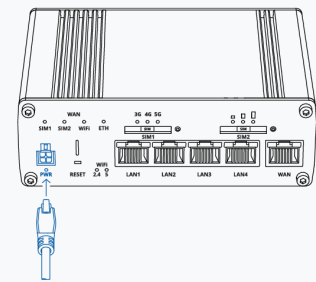

Configure your computer (Windows)

1. Ensure the Wireless network connection is Enabled. Go to Start — Control Panel — Network and Internet — Network and Sharing Center. Click on the **Change adapter settings** in the left panel, then right-click on Wireless Network Adapter, and select Enable.

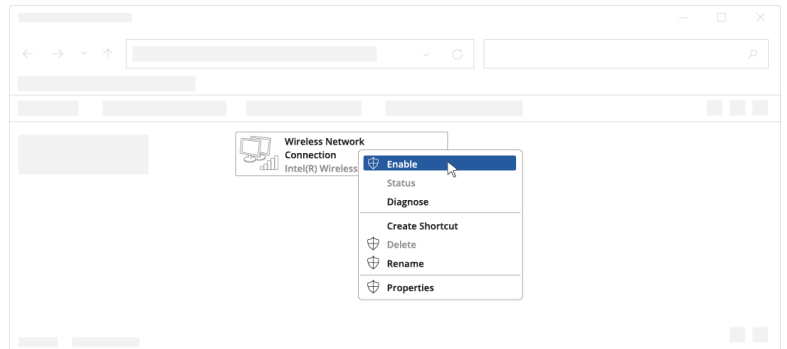

2. Check if IP and DNS are obtained automatically. Right-click on Wireless Network Adapter and select Properties. Then select **Internet Protocol Version 4** and click Properties.

3. If not selected, check to **obtain an IP address** and **obtain DNS server address automatically**. Click OK.

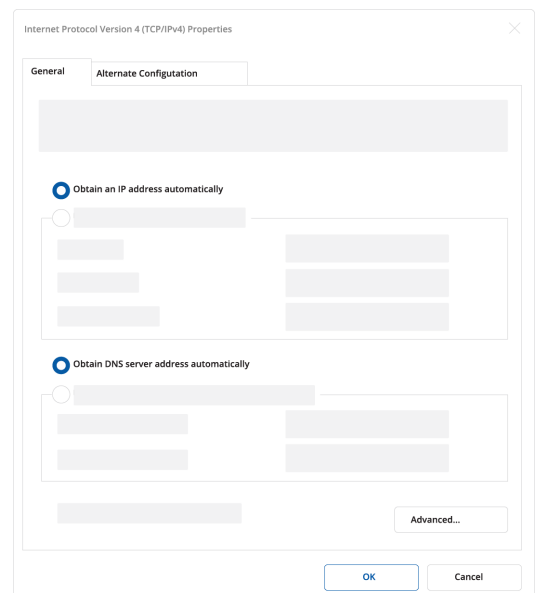

4. Connect to a wireless network by right-clicking on Wireless Network Adapter and selecting Connect.

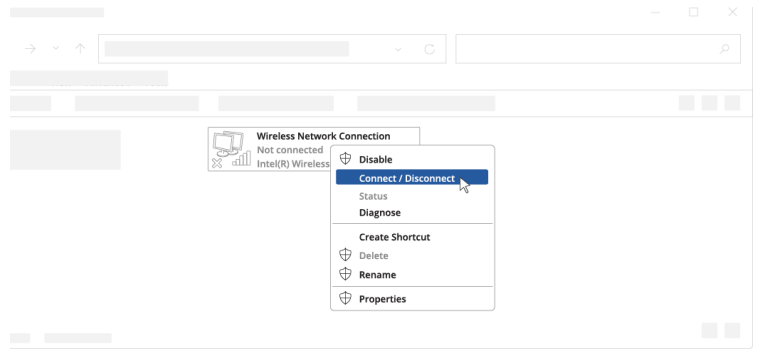

5. Choose the wireless network RUTX50 **** from the list and click Connect. Enter the WiFi password located on the device's label.

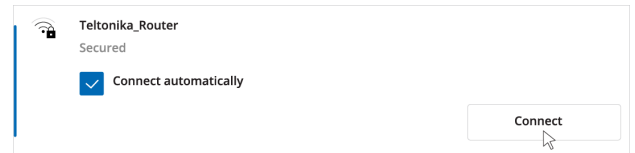

Login to device

1. To enter the router's Web interface (WebUI), type `http://192.168.1.1` into the URL field of your Internet browser.

2. When prompted for authentication enter the username `admin` and enter the password located on the device information label/engraving.

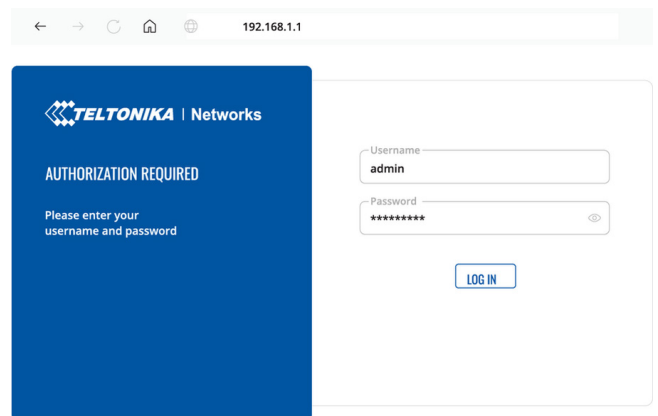

3. After logging in, you must set a new password for security reasons. You will not be able to interact with the router's WebUI until the default password is changed. The new password must consist of a minimum of **8 characters**. Requirements: one uppercase letter, one lowercase letter, and one digit.

4. Next, the Configuration Wizard will start to help you set up some of the router's main operational parameters (see page 7).

5. Finally, let's verify the Mobile signal strength. Go to the **Status — Network** page and pay attention to the **Signal Strength** indication.

To achieve the best signal conditions and maximize cellular performance, try adjusting the antennas or changing the location of your device.

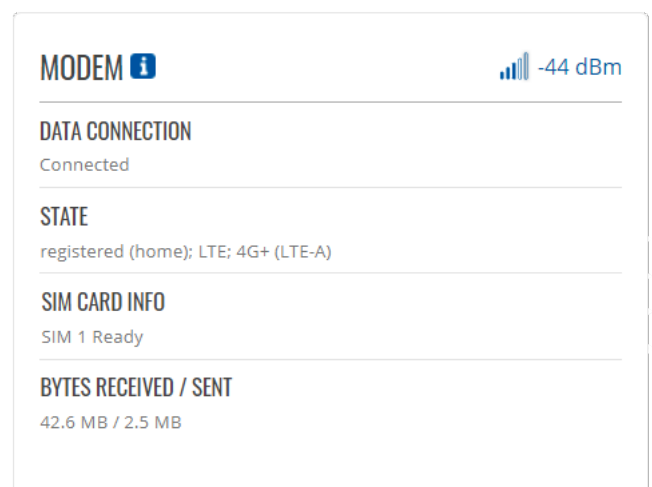

SIM card recommendations

- Before installing the SIM cards, please apply a thin layer of dielectric grease to the SIM card contacts for devices used in environments with **high-vibration levels**. This will help avoid SIM cards losing touch with the SIM slot and prevent unexpected failures.
- Industrial Grade SIM cards are recommended for devices requiring a long lifespan used in environments with **extreme temperatures, corrosive** or **extra humid climates**, or hard-to-reach locations.

Router powering options

Power socket

The router has a 4 pin power socket and can be powered by a 9-50 VDC power supply unit (PSU). Refer to the image below for the power socket's pinout information:

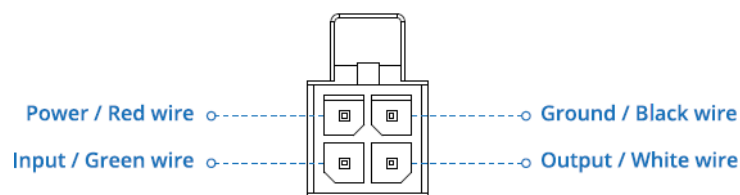

If you decide not to use the standard 9 VDC wall adapter and want to power the device from a higher voltage (15-50 VDC), please make sure that you choose a power supply of high quality. Some power supplies can produce voltage peaks significantly higher than the declared output voltage, especially during connection and disconnection.

While the device is designed to accept input voltage of up to 50 VDC peaks, high voltage power supplies can harm the device. If you want to use high voltage power supplies it is recommended to also use additional safety equipment to suppress voltage peaks from the power supply.

Passive PoE

The device may also be powered by an Ethernet cable via the LAN1 port. **Do not use in other ports.**

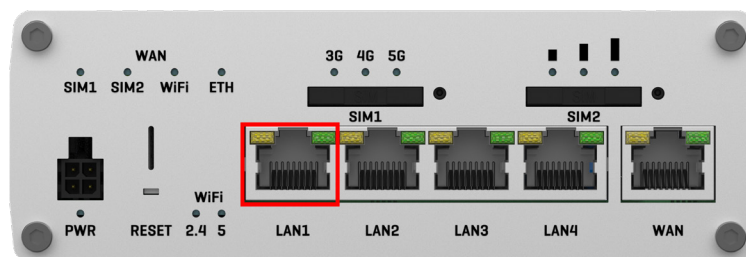

- The device is **NOT COMPLIANT** with the IEEE 802.3af-2003 standard: powering the device from an IEEE 802.3af-2003 power supply will **damage the device** as it is not rated for input voltages of the PoE standard.
- The device is **NOT COMPLIANT** with the IEEE 802.3at standard: it cannot power other devices over Ethernet.

Router label

On the back of the router there's a label as shown in the example below.



Please take note of these important info before installing the router.

These info are requested in case of router reset and to enable the remote management system. Please copy the info down here:

SERIAL	_____
LAN MAC	_____
WIFI PASSWORD	_____

Router Setup Wizard

The Setup Wizard is a tool that offers a simplified version of other WebUI pages used to set some of the most relevant device parameters: **Time / LAN / WAN / WiFi / RMS**

You will be greeted with the Setup Wizard the first time you login, after you have changed the device default password. On other logins you will be redirected to the Overview page, but you can reach the Setup Wizard any time via the System > Setup Wizard page.

This page is an overview of the Setup Wizard tool.

General

The **General** section is used to configure the device's time, language and WebUI mode settings.

WEBUI SETTINGS

Language

Configuration mode

GENERAL SETTINGS

Current system time 11/22/2022, 11:53:25 AM

[SYNC WITH BROWSER](#)

Time zone

[SKIP WIZARD](#)

[NEXT](#)

LAN

The **LAN** section is used to configure the device's local area network (LAN) and DHCP server settings. A DHCP (Dynamic Host Configuration Protocol) server can automatically configure the TCP/IP settings for any device that requests such a service. If you connect a device that has been configured to obtain an IP address automatically, the DHCP server will lease out an IP address from the available IP pool and the device will be able to communicate within the device's private network.

See the reference picture on the following page

LAN CONFIGURATION

IPv4 address

IPv4 netmask

DHCP CONFIGURATION

Enable DHCP

Start IP

End IP

Lease time

[BACK](#)
[SKIP WIZARD](#)
[NEXT](#)

Mobile

The **Mobile** section is used to configure the device's SIM card parameters.

MOBILE CONFIGURATION | MOB1S1A1

Auto APN off on

Connection is or will be established without using APN

PIN

[< BACK](#)
[SKIP WIZARD](#)
[NEXT](#)

Field	Value	Description
Auto APN	off on; default: on	An Access Point Name (APN) is a gateway between a GSM, GPRS, 3G or 4G mobile network and another computer network. Depending on the contract, some operators may require you to enter the APN just to complete the registration to a network. In other cases an APN is used to get special parameters from the operator (e.g., a public IP address) depending on the contract. Auto APN scans an internal Android APN database and selects an APN based on the SIM card's operator and country. If the first automatically selected APN doesn't work, it attempts to use the next existing APN from the database.
PIN	string; default: none	A 4-digit long numeric password used to authenticate the modem to the SIM card.

WiFi

The WiFi section is used to configure the device's WiFi Access Points (APs). The router supports two types of WiFi: 2.4 GHz and 5 GHz. 2.4 GHz WiFi provides better coverage and works at a longer range, but has lower data transfer speeds when compared to 5 GHz WiFi.

See the reference picture on the following page

^ WIFI 2.4 GHZ

Enable off on

ESSID

Password 

^ WIFI 5 GHZ

Enable off on

ESSID

Password 

[< BACK](#)
[SKIP WIZARD](#)
[NEXT](#)

RMS

This section is used to configure the settings required to connect the device to the **RMS (Remote Management System)** - a cloud system designed by Teltonika and intended for remote monitoring and management of Teltonika-Networks products.



∨ RMS SETTINGS

Connection type 

Hostname

Port

∨ STATUS

Management status	Enabled
Connection state	Failure (Error: Failed to resolve hostname.)
Serial number	1114921763 
Lan MAC	00:1E:42: 
Next connection after	00:00:08

[CONNECT](#)
[SAVE & APPLY](#)

Router APP for Android and iOS



Teltonika RutOS is an application developed for Android and for iOS to have complete control and monitor of the router. It offers a WiFi and device list for wireless connectivity control and Traffic Charts to analyse your internet speed accurately and a Dashboard where you can see all the crucial metrics of connected devices.

You can download the app **Teltonika RutOS** for free on Goggle Play and App Store.

Router supported frequency bands

Different countries and network operators use different frequency bands for communication in their respective mobile networks. Therefore, in order to communicate within an operator's network, the mobile equipment has to support the frequency bands used by that operator.

Router code	Region (Operator)	Supported Bands
RUTX50 0*****	Europe, the Middle East, Africa, Oceania, Brazil, Brazil	<ul style="list-style-type: none"> • 5G (NR NSA/SA): n1 (2100 MHz), n3 (1800 MHz), n5 (850 MHz), n7 (2600 MHz), n8 (900 MHz), n20 (800 MHz), n28 (700 MHz), n38 (2600 MHz), n40 (2300 MHz), n41 (2500 MHz), n77 (3700 MHz), n78 (3500 MHz) • 4G (LTE-FDD): B1 (2100 MHz), B3 (1800 MHz), B5 (850 MHz), B7 (2600 MHz), B8 (900 MHz), B20 (800 MHz), B28 (700 MHz), B32 (1500 MHz) • 4G (LTE-TDD): B38 (2600 MHz), B40 (2300 MHz), B41 (2400 MHz), B42 (3500 MHz), B43 (3600 MHz) • 3G: B1 (2100 MHz), B5 (850 MHz), B8 (900 MHz)

Router user manual

All the information regarding the router are hosted by a Wiki page which contains user manuals, configuration guides, certification information and much more.

Please find it at the following internet address: https://wiki.teltonika-networks.com/view/RUTX50_Manual

Router mounting accessories



Router DIN rail kit

MA-1

cod. PF AC NBASE021



Router compact DIN rail kit

MA-2

cod. PF AC NBASE022



Router surface mounting kit

MA-3

cod. PF AC NBASE023



Cigarette lighter power supply

PI-3

cod. PF AC AMP04



Power cable with 4-way screw terminal

PI-4

cod. PF AC AMP05



This sign on the package means that all used electronic and electric equipment should not be mixed with general household waste.



Hereby, SCOUT declares that this system is in compliance with the essential requirements and other relevant provisions of Directive 2014/53/EU. The full text of the EU declaration of conformity is available at the following internet address: https://wiki.teltonika-networks.com/view/RUTX50_CE/RED



Hereby, SCOUT declares that the radio equipment is in compliance with Radio Equipment Regulations 2017. The full text of the UK declaration of conformity is available at the following internet address: https://wiki.teltonika-networks.com/view/RUTX50_UKCA